

## **The Performance of Bali's IMRO POESAT500 Satellite Ground Station**

Rizki Hanintyo, Eko Susilo  
Institute for Marine Research and Observation  
Jl. BaruPerancak, Jembrana, Bali 82251 - Indonesia  
E-mail: rizki.hanintyo@yahoo.com

**Abstract:** Institute for Marine Research and Observation (IMRO) has been established a Satellite Ground Station that able to receive NOAA-AVHRR data and MetOp-A data and SARAL data. In this paper, we would like to explain and demonstrate the ability of IMRO POESAT500 Satellite Ground Station. The ground station equipped with a 2.4 m diameter of L-Band Antenna. ThisSATRAK-550 antenna made by Environmental System & Services (ESS). POESAT500 are using 2 kinds of receiver module to receive all mentioned data. AMetcom Quorum module dedicated to receiving NOAA and METOP-A data and an ESS3000 module to receive SARAL data. There is 2 kinds of workstation, an Acquisition Workstation (AWS) and a Data Processing System Workstation (DPS) dedicated to processing all level-0 product to level-1b and level-2 product. These ground station provide near real-time data, both oceanographic and meteorological parameter, all around Indonesia regions to support the Indonesia Operational Oceanography Program. Improvement and upgrading still needed to enhance the IMRO POESAT500 Satellite Ground Station capability to be able to downlink and processanother satellite product.

**Keywords:** IMRO, POESAT500 Ground Station, NOAA AVHRR Satellite, MetOp-A Satellite

### **1. Introduction**

Institute for Marine Research and Observation (hereafter IMRO) is a research center on behalf of Ministry of Fisheries and Marine Affairs of Republic Indonesia. IMRO was established in 2005. The main task of IMRO based on Ministry Act No.34/MEN/2011 is to conduct studies and observation on marine resources for example, physical oceanography and marine chemistry, potential fishing grounds, climate change, and ocean modeling. IMRO has a vision to become a center of excellence in marine resources research and observation. With this vision, IMRO tries to achieve resource capacity on marine resources research and observation that is reliable and independent, mastery applied science and technology for marine resources research and observation supported by good data and information.

IMRO has a mandate to provide near real-time remote sensing data to support the Indonesia Operational Oceanography Program. The main ideas of the Indonesia Operational Oceanography Program came from 2005 through Southeast Asia Center for Ocean Research and Monitoring (SEACORM) initiative. The aim of this program is to collect near real-time and provide oceanographic dataforecast in Southeast Asia. There's a lot of cooperation, research partnership and purchasing equipment that able to achieve this goal. According to those responsibilities, IMRO has been established a Satellite Ground Station since 2003. The first satellite data received in this stationis NOAA AVHRR data. Started in 2012, IMRO grounded a new satellite receiving station that able to receive NOAA AVHRR 15 - 19, and MetOp-A data.

In this paper, we would like to explain and demonstrate the capability of IMRO POESAT500 Ground Station. Starting from the process until the output of the ground station. As the result, we will able to complete satellite observation along Indonesian areas that can be used as an important input for ocean model process, generate potential fishing ground, forecast ocean dynamics, and other applications. In Indonesian areas, there's several Satellite Ground Station , for example Satellite Ground Station of LAPAN (Indonesian Aerospace Agency) in Parepare (Setyasaputra, 2015 and Suprijanto, 2016). An automated data processing has been achieved by LAPAN to process NOAA and METOP A/B (Suprijanto, 2016), the same data as we receive. The goals of our system measured by ability to retrieve all those satellite data day by day. Capability to create cloudless data automatically from remote sensing data is being planned on our system.

## 2. System overview

### 2.1. General Overview of POESAT500

The POESAT500 is a high-performance system that can tracks, receives and processes data from the US NOAA, EUMETSAT MetOp, and NSMC Fengyun-1 spacecraft series (ES&S, 2010). In operation (see fig 2.1.1), the antenna will track the satellite when visible from the station and collection of the L-band signal (ES&S, 2011). The satellite pass schedule is calculated at midnight and downlink process is calculated 2 minutes prior to passing. The satellite transmissions are received by the dish antenna through LNA and down-converter. The signals are processed by the receiver inside the Acquisition Workstation. This pre-processed data will be sent to the Data Processing System where the final image products are generated and transferred for further analysis. All of these processes is automatic.

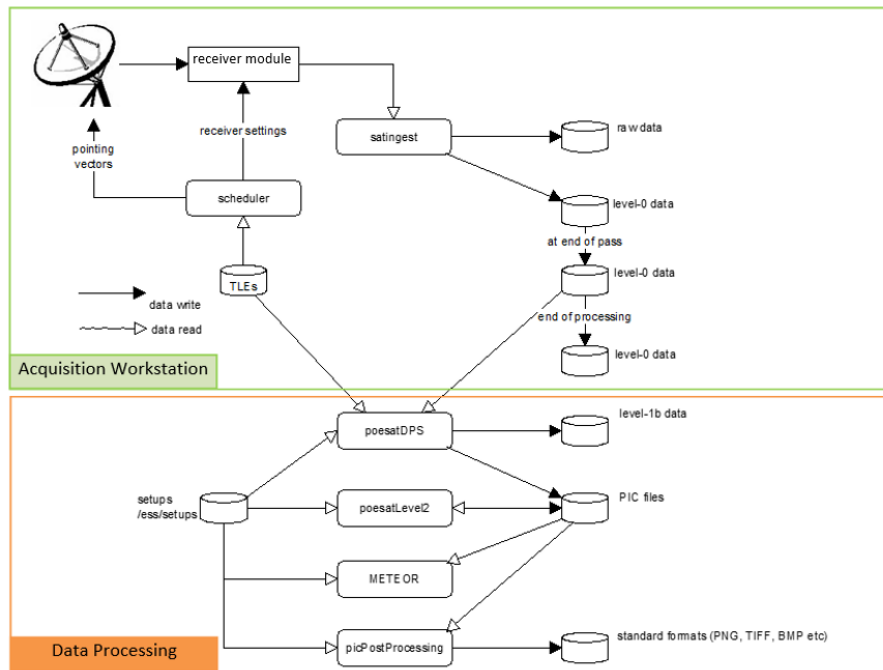

Fig. 2.1.1. Typically System Operation of POESAT500 Satellite Ground Station

### 2.2. IMRO POESAT500 System Components

As a full system, IMRO POESAT500 Satellite Ground Station system consists of 4 sub-systems, an Antenna, Acquisition Workstation (AWS), Data Processing System (DPS), and Display Workstation (DW) (ES&S, 2011). All sub-system placed in one rack server and able to scaled up to update the system. All sub-system backed up with one Uninterruptible Power Supply (UPS) with 6 KVA power capacity. Fig. 2.2.1 explain system configuration of IMRO POESAT500 Satellite Ground Station.

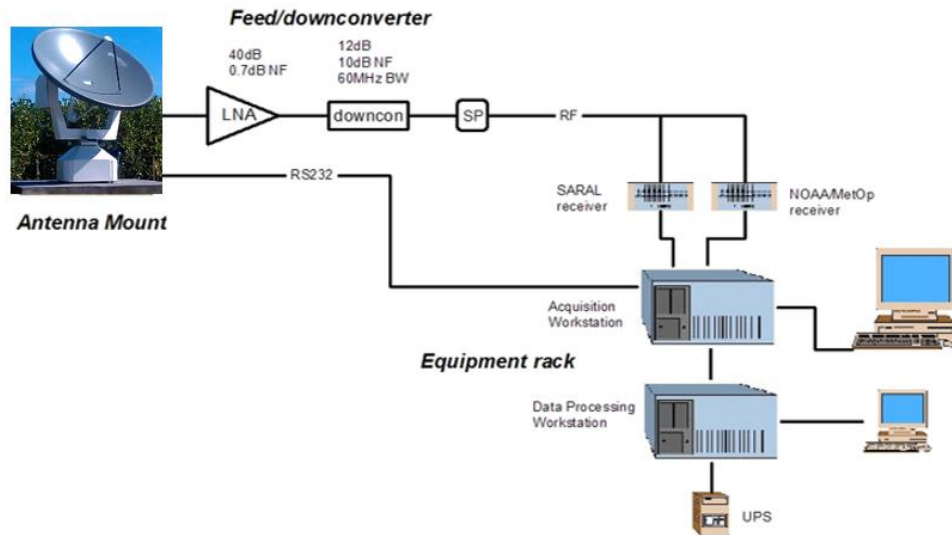

Fig. 2.2.1. System Configuration of IMRO POESAT500 Satellite Ground Station

### 2.2.1. Antenna Sub-system

IMRO POESAT500 Satellite Ground Station is using ES&S antenna system SATRAK 550 series. This antenna system uses L-Band to receive satellite signal with the frequency 1682 - 1710 Mhz. The antenna has 2.4 m diameter and has 0.05-degree pointing accuracy. Integrated feed / down converter from Quorum was used to deliver the L-Band signal. The antenna mounted on 4.2-meter tower and placed over free view antenna horizon on 5-degree limit. The detailed information regarding the antenna sub-system refers to Table 1 and the ES&S SATRAK 550 in Fig. 2.2.1.

Table 2.2.1.1. Detailed Information of Antenna Sub-system

Description	
Mount Configuration	X/Y
Antenna Diameter	2.4 meter
Pointing Accuracy	0.05 degree
Wind Loading (Operational)	120 km/hr
Wind Loading (Survival)	220 km/hr
Slew Rate	>5 degrees/sec
Environmental	IP 65
Power Supply	110/220/240 AC
Temperature Supply	-10 to 45 degree C
Feed & LNA	
Gain	45 dB
Noise Fig.	45 degree K
Frequency	L-Band : 1682 - 1710 Mhz
Polarization	Right Hand Circular Polarization / RHCP
LNA gain	45 dB



Fig. 2.2.1.1. The SATRAK 550 Antenna in IMRO Ground Station

The control system of antenna uses standard, off the shelf available, industrial control components found in many other motion control systems. The Antenna can be equipped with various RF Components as feed and downconverters to suit various applications. The control system uses two almost identical servo motor arrangement for azimuth position and elevation position. Each servo motor consists of:

1. Servo Driver (Kinetix 300)
2. Motor
3. Gearbox
4. Limit switches and home position sensor.

And other components in the antenna are Programmable Logic Controller (PLC)–CompactLogix. The PLC is a computer that controls both servos and communicates with a display unit (HMI) and workstations. All the active control components (servo motor driver, PLC, and HMI) communicate through Ethernet. The tracking antenna receives commands via the host interface from a computer. The command interface is a serial RS232 interface. The command goes through MOXA modem TCC100x on both sides, antenna and rack server side. An Emergency Stop Button provided for safety reason.

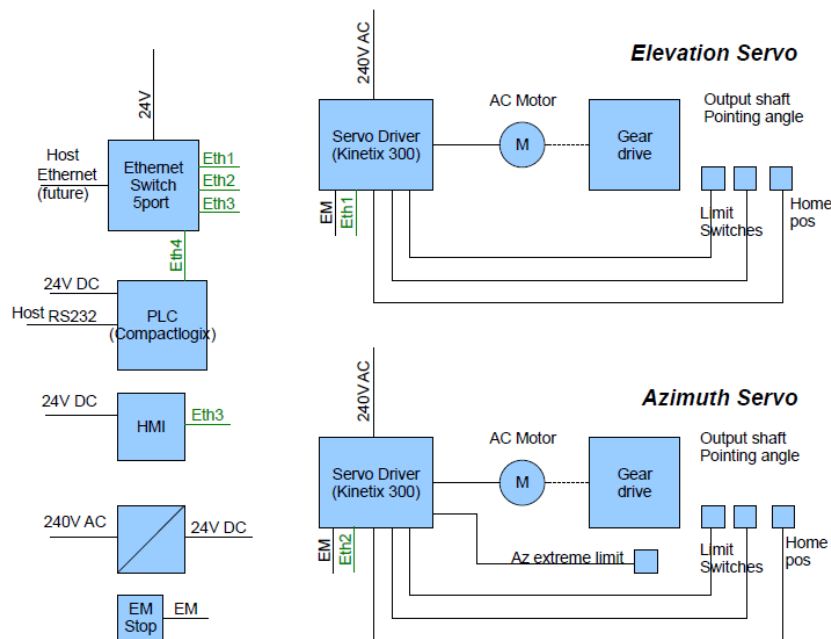

Fig. 2.2.1.2. Schematic Diagram of SATRAK 550System

### 2.2.2. Acquisition Workstation Sub-system

The Acquisition Workstation (AWS) consist of 4 Intel Core2 Quad CPU with 4 GB of memory runs under Redhat Linux 6.1 environment. For a storage device, AWS using 1 TB of a storage device and mounted on several directories and also equipped with 4 TB of NAS. This NAS will be used to backup previous level-0 and level-1 product in case of low storage availability. To maintain the free disk space on mounted drive some modification on crontab have been done to move old data from storage device to our NAS drive after one week. Details of the CPU system, memory module and storage device of AWS in Table 2.2.2.1.

Table 2.2.2.1. Detailed Information of Acquisition Workstation Sub-system

Description	
Architecture	i686
CPU(s)	4
CPU Family	6
CPU Mhz	2000
RAM	4 GB
Storage	1 TB
NAS	4 TB
OS	Redhat Linux 6.1 (Santiago)

The Acquisition Workstation (AWS) has several tasks to do as central for the receiver and pre-processes the raw data. First, AWS control antenna to its fixed position when certain satellite came in antenna horizon. The AWS download Two Line Elements (TLE) through Celestrakwebsite (<https://www.celestrak.com/NORAD/elements/>). After TLE updated twice a day, SATRAK uses a proprietary program to produce high accuracy path prediction. The prediction will be showed in the scheduler that will inform operators when the antenna tasked to receive data. Fig. 2.2.2.1 show information about scheduler console on AWS. In scheduler on tab 'list', operators able to see which data will be downlinked in certain time period. The scheduler will not receive any satellite which has elevation degree less than 15 degrees and 2 satellite pass which has conflicted time period. The schedule shows the satellite passes for the next 48 hours and those the system has scheduled over the previous week and can be viewed from the scheduler tab in the console Fig. 2.2.2.1.

There are seven information displayed in the console related to the satellite passes schedule:

1. **Satellite**, name of the satellite
2. **Start time**, date and time of the start of the pass
3. **Duration**, the duration, in seconds, of the pass
4. **Maximum elevation**, the satellite's highest point in the sky, in degrees. Very low passes are not tracked by the system.
5. **Flag**, the category of the pass, which can be:
  - 's': the pass will be tracked as it meets minimum elevation requirements and does not conflict with other passes of a higher priority. Data will be acquired for this pass,
  - 'x': the pass will not be tracked. The satellite may indeed be visible but does not reach the minimum elevation required. No data will be acquired, or
  - 'p': the pass will not be tracked. The pass conflicts with another pass from a satellite having a higher priority. No data will be acquired.
6. **File name**, name of the level-0 file written to the directory
7. **Size**, size of the level-0 file. Updates during the pass

List	Satellite	Start time	Durn	M.el	Flag	f :
Pass	NOAA 18	09-01 20:38:54	966	68.7	s	
	SARAL	09-01 21:53:59	890	39.6	s	
	NOAA 15	09-01 22:12:50	837	21.3	s	
	NOAA 18	09-01 22:24:52	317	1.3	x	
	SARAL	09-01 23:34:19	731	12.8	x	
	METOP-A	09-02 00:31:28	768	14.1	x	
	METOP-A	09-02 02:10:01	911	38.6	s	
	NOAA 19	09-02 05:21:05	868	22.2	s	
	NOAA 19	09-02 07:01:24	889	26.4	s	
	NOAA 19	09-02 07:33:33	833	16.3	s	

Countdown: 22:33    wait for pass    NOAA 19    UTC: 2014/09/02 06:38:5

Fig. 2.2.2.1. Scheduler Console on AWS

The second task is to configure the receiver module to the relevant spacecraft mode. POESAT500 have 2 types of a receiver to receive satellite data. Metcom Quorum LRD - 100 module to receive NOAA and MetOp-A data and ESS3000 Multimode module to receive SARAL data. The last task is to generate level-0 product and transferred near real-time to next processing.

### 2.2.3. Data Processing System Sub-system

The Data Processing System (DPS) hold task to receives pre-processed data from the AWS and produces final image products according to user-defined setups. There are software that will be launched to process and to generate level-1b files from level-0 product and convert it into PIC files. In DPS also a software called METEOR, a multi-platform satellite image displays and analysis application. It includes extensive image analysis functions and has been enhanced with extra functionality to make it particularly suitable for the analysis of remote sensing data. Generally, METEOR can be used to display imagery from Aqua and Terra MODIS, NOAA HRPT, Fengyun 1D CHRPT, MTSAT LRIT HRIT and HiRID, Fengyun 2C/D/E SVISSR, and others. This software will convert level-1b product to level-2 product from each imagery. By using the recent configuration, the process can be done within 15 -30 minutes. All the level-2 product stored on 500 GB storage. We didn't apply the same crontab yet to a backup old level-2 product as we did in AWS.

## 3. Result and Discussion

As the DPS process all level 1-b data, METEOR will generate level 2 data from each satellite pass and stored in DPS. List of Level 2 data generated from METEOR listed in Table 3.1. As we can see in table 3.1, the Level-2 data consist of information of Sea, Land and cloud parameters, such as SST, LST, Water Vapour, Precipitation Index, and Cloud Information. Those data will be used in IMRO as an input of ocean models.

Table 3.1. List of Level-2 Product Generated by METEOR

Channel	Product	Channel	Product
<b>MTSAT</b>			
- Total Precipitable Water	ATOVS	Cloud Amount Total	Cloud Properties
- Total Ozone	ATOVS	Cloud Top Pressure - default	Cloud Properties
- Surface Water Vapour	ATOVS	Cloud Type	Cloud Properties
- Surface Temperature	ATOVS	Metop_CH4-default	LIB
- Surface Pressure - default	ATOVS	LST-default	LSTMOSAIC
- Surface Pressure	ATOVS	LST	LSTMOSAIC
- Surface Emissivity	ATOVS	LST	Surface Properties
- Cloud Top Pressure	Cloud Properties	1050.0hPa-default	Temperature Profile
- Cloud Top Height	Cloud Properties	1050.0hPa	Water Vapor Profile
- Cloud Top Temperature	Cloud Properties		
<b>NOAA</b>			
- AMSU_CH1	AMSUA	SST-default	SSTMOSAIC
- AMSU_CH1-default	AMSUA	SST-default	Surface Properties
- AMSUB_CH1-default	AMSUB	0.1hPa	Temperature Profile
- AMSUB_CH1	AMSUB	0.2hPa	Temperature Profile
- Cloud Fraction	ATOVS PRODUCT	1.0hPa	Temperature Profile
- Total Precipitable Water	ATOVS PRODUCT	2.0hPa	Temperature Profile
- Surface Pressure	ATOVS PRODUCT	4.0hPa	Temperature Profile
- Surface Water Vapor	ATOVS PRODUCT	7.0hPa	Temperature Profile
- Precipitation Index	ATOVS PRODUCT	15.0hPa	Temperature Profile
- Total Ozone	ATOVS PRODUCT	25.0hPa	Temperature Profile
- Surface Pressure-default	ATOVS PRODUCT	50.0hPa	Temperature Profile
- Surface Emissivity	ATOVS PRODUCT	70.0hPa	Temperature Profile
- Surface Temperature	ATOVS PRODUCT	100.0hPa	Temperature Profile
- Cloud Top Temperature	Cloud Properties	135.0hPa	Temperature Profile
- Cloud Amount Total	Cloud Properties	200.0hPa	Temperature Profile
- Cloud Top Height	Cloud Properties	250.0hPa	Temperature Profile
- Cloud Top Pressure - default	Cloud Properties	350.0hPa	Temperature Profile
- Cloud Top Pressure	Cloud Properties	430.0hPa	Temperature Profile
- Cloud Type	Cloud Properties	500.0hPa	Temperature Profile
- HIRS_CH1	HIRS	850.0hPa	Temperature Profile
- HIRS_CH1-default	HIRS	950.0hPa	Temperature Profile
- NOAA_CH4-default	LIB	1025.0hPa	Temperature Profile
- NOAA_CH4	LIB	1050.0hPa	Temperature Profile
- LST-default	LSTMOSAIC	1050.0hPa-default	Temperature Profile
- 0.1hPa	Moisture Profile	0.1hPa	Water Vapor Profile
- 0.2hPa	Moisture Profile	0.2hPa	Water Vapor Profile
- 1.0hPa	Moisture Profile	1.0hPa	Water Vapor Profile
- 2.0hPa	Moisture Profile	2.0hPa	Water Vapor Profile
- 4.0hPa	Moisture Profile	4.0hPa	Water Vapor Profile
- 7.0hPa	Moisture Profile	7.0hPa	Water Vapor Profile
- 15.0hPa	Moisture Profile	15.0hPa	Water Vapor Profile
- 25.0hPa	Moisture Profile	25.0hPa	Water Vapor Profile
- 50.0hPa	Moisture Profile	50.0hPa	Water Vapor Profile
- 70.0hPa	Moisture Profile	70.0hPa	Water Vapor Profile
- 100.0hPa	Moisture Profile	100.0hPa	Water Vapor Profile
- 135.0hPa	Moisture Profile	135.0hPa	Water Vapor Profile
- 200.0hPa	Moisture Profile	200.0hPa	Water Vapor Profile
- 250.0hPa	Moisture Profile	250.0hPa	Water Vapor Profile
- 350.0hPa	Moisture Profile	350.0hPa	Water Vapor Profile
- 430.0hPa	Moisture Profile	430.0hPa	Water Vapor Profile
- 500.0hPa	Moisture Profile	500.0hPa	Water Vapor Profile
- 850.0hPa	Moisture Profile	850.0hPa	Water Vapor Profile
- 950.0hPa	Moisture Profile	950.0hPa	Water Vapor Profile
- 1025.0hPa	Moisture Profile	1025.0hPa	Water Vapor Profile
- 1050.0hPa	Moisture Profile	1050.0hPa	Water Vapor Profile
- 1050.0hPa-default	Moisture Profile	1050.0hPa-default	Water Vapor Profile

Until now, IMRO POESAT500 Ground Station have already collected more than 1800 scenes of NOAA level-2 product and more than 500scenes of MetOp level-2 product and still counting. In the

end of the year, IMRO is preparing to launch web portal to public. This web portal aim is to disseminate all this IMRO POESAT500 Ground Station product. Through this web portal (Fig. 3.1), a user can look around and download a single product or all the dataset available mentioned in Table 3.1. There is 5 available data format for each data i.e PIC format, HDR format, NetCDF format, HDF4 format, and HDF5 format. Fig. 8 show an overview of IMRO Ground Station web portal.

**Product images**

Showing results 1 - 15 of 1432  
Images per page: 15 Sorted by: Newest First

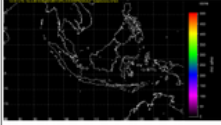
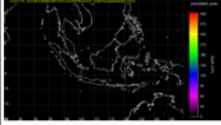
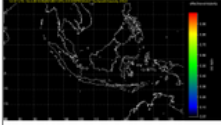
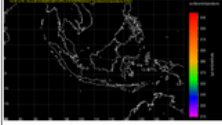
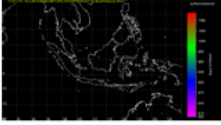
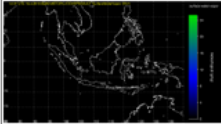
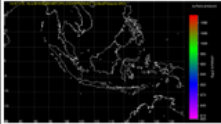
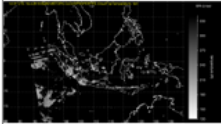
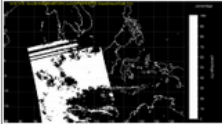
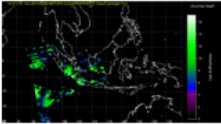
<b>19 April 2016</b> MTA 14:37	<b>19 April 2016</b> MTA 14:37	<b>19 April 2016</b> MTA 14:37	<b>19 April 2016</b> MTA 14:37	<b>19 April 2016</b> MTA 14:37
				
Channel: <b>TotalOzone</b> Product: <b>ATOVSPRODUCT</b> Setup: <b>BaliM</b> <a href="#">Download</a>	Channel: <b>TotalPrecipitableWater</b> Product: <b>ATOVSPRODUCT</b> Setup: <b>BaliM</b> <a href="#">Download</a>	Channel: <b>SurfaceEmissivity</b> Product: <b>ATOVSPRODUCT</b> Setup: <b>BaliM</b> <a href="#">Download</a>	Channel: <b>SurfaceTemperature</b> Product: <b>ATOVSPRODUCT</b> Setup: <b>BaliM</b> <a href="#">Download</a>	Channel: <b>SurfacePressure</b> Product: <b>ATOVSPRODUCT</b> Setup: <b>BaliM</b> <a href="#">Download</a>
<b>19 April 2016</b> MTA 14:37	<b>19 April 2016</b> MTA 14:37	<b>19 April 2016</b> MTA 14:37	<b>19 April 2016</b> MTA 14:37	<b>19 April 2016</b> MTA 14:37
				
Channel: <b>SurfaceWaterVapor</b> Product: <b>ATOVSPRODUCT</b> Setup: <b>BaliM</b> <a href="#">Download</a>	Channel: <b>SurfacePressure-default</b> Product: <b>ATOVSPRODUCT</b> Setup: <b>BaliM</b> <a href="#">Download</a>	Channel: <b>CloudTopTemperature</b> Product: <b>CLOUDPROPERTIES</b> Setup: <b>BaliM</b> <a href="#">Download</a>	Channel: <b>CloudAmountTotal</b> Product: <b>CLOUDPROPERTIES</b> Setup: <b>BaliM</b> <a href="#">Download</a>	Channel: <b>CloudTopHeight</b> Product: <b>CLOUDPROPERTIES</b> Setup: <b>BaliM</b> <a href="#">Download</a>

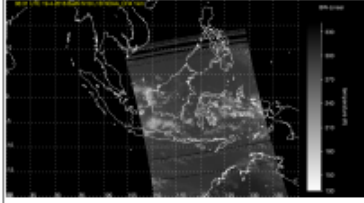

**Satellite: N19**  
**Channel: NOAA\_CH4-default**  
**Product: L1B**  
**Setup: BaliN**  
**Date: 19 April 2016**  
**Time: 06:31**

**Selection Formats**

1 PNG (png)

**Base Formats**

1 ESS PIC (pic)

1 ESS HDR (hdr)

1 NetCDF (nc)

1 HDF4 (hdf)

1 HDF5 (h5)

[Download](#)

Fig. 3.1. IMRO Ground Station Web Portal



#### 4. Conclusion and Recommendation

The goals of our system measured by ability to retrieve all those satellite data day by day. Capability to create cloudless data automatically from remote sensing data is being planned on our system. Data collection of our system still running well and in daily basis, we're analyzing those data from satellite to produce a lot of oceanographic monitoring. In next year, we will conducting research on cloudless data automatically.

IMRO plan to upgrade the POESAT500 Ground Station capability to receive a MetOp-B data due to degraded performance on MetOp-A satellite. There're few works to receive those data, such as upgrading down converter, upgrade receiver, and also upgrade the processor. Therefore, it is recommended to generate free cloud level-3 product from all level-2 product than disseminate in our web portal.

#### 5. Acknowledgement

We would like to say our appreciation to Institute for Marine Research and Observation for funded our research. Also our higher appreciation for Head of IMRO, Dr. Bambang Sukresno. A support of IMRO Ground Station during installation and operational to our Operators and all technician and engineers.

#### References

- 1). ES&S. POESAT500: *Groundstation Quickstart User Guide (Revision 1)*. Australia: Environmental Systems & Services Pty Ltd, 2010.
- 2). ES&S. POESAT500: *System Manual Theory of Operation and Description of System Software Version 2.5(Revision 1)*. Australia: Environmental Systems & Services Pty Ltd, 2011.
- 3). ES&S: METEOR. *Satellite Image Display and Analysis. User and Installation Manual Version 3.28 (Revision 1)*. Australia: Environmental Systems & Services Pty Ltd, 2011.
- 4). Setyasaputra, Nurmajid, Arif Hidayat, Ahmad Luthfi Hadiyanto, Sutan Takdir Ali Munawar: *Analisis Kebutuhan Integrasi Antena Orbital Diameter 3.0 dengan Sistem yang Telah Beroperasi di Stasiun Bumi Balai Penginderaan Jauh Parepare*. Proceeding of "Seminar Nasional Penginderaan Jauh - 2015", 2015.
- 5). Suprijanto, Agus, Nurmajid Setyasaputra, Sutan Takdir Ali Munawar: *Integrasi Antena Data Satelit Resolusi Rendah di Stasiun Bumi Penginderaan Jauh Parepare*. Proceeding of "Seminar Nasional Penginderaan Jauh - 2016", 2016.
- 6). Suprijanto, Agus, Sutan Takdir Ali Munawar, Ardiansyah: *Otomatisasi Sistem Pengolahan Data Sateli NOAA 18/19 dan METOP A/B di Stasiun Bumi Penginderaan Jauh Parepare*. Proceeding of "Seminar Nasional Penginderaan Jauh -2016", 2016.